

Article number: 201302024

Description: E+G  
Keyring GN 111.3-24

## Measures

---

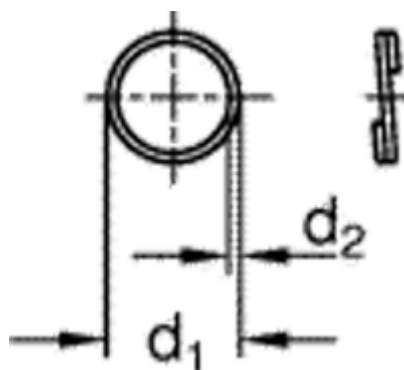

$d_1 = 24$

$d_2 = 1.5$